

Data Sheet

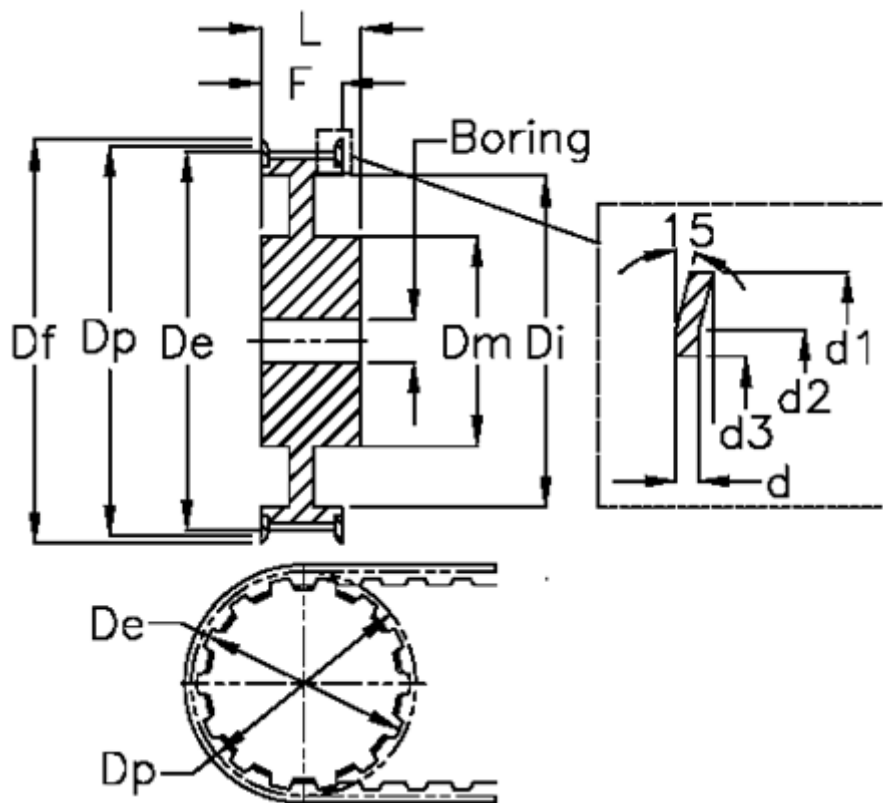

Article number: 604145048040
 Description: Timing belt pulley with hub
 HTD 48 14M 40

Measures



Bore = 24	Dm = 135	Width = 40
d = 2.5	Dp = 213.9	
d1 = 226	F = 170	
d2 = 214	Flange type = F62	
d3 = 190	L = 54	
De = 211.11	Tooth number = 48	
Df = 226	Type = 14M	
Di = 69	Weight = 11.5	